

# WANROOEMED

YOUR IDEAL OPERATING TABLE SUPPLIER  
MEET THE VARIOUS REQUIREMENTS OF GENERAL SURGERY

## A0T700S

Electro-hydraulic  
Operating Table

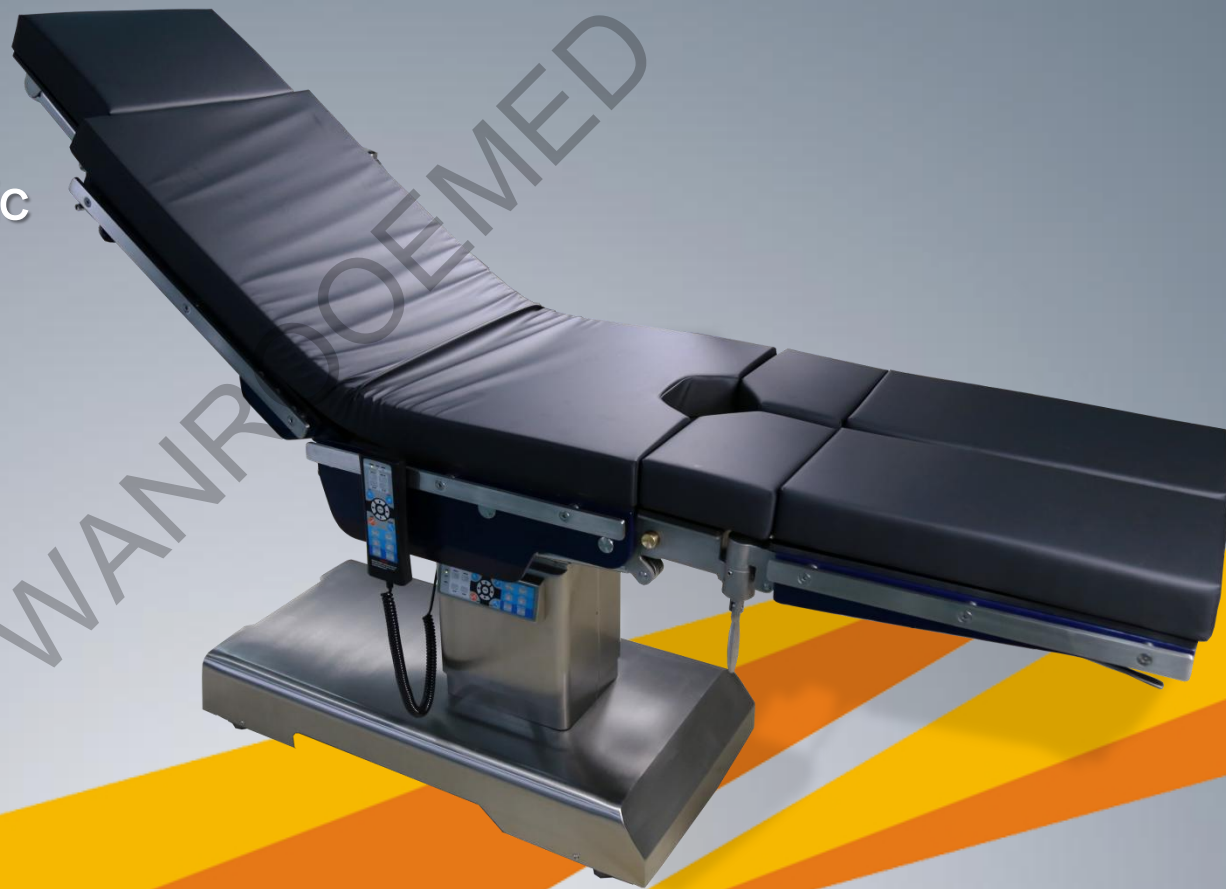

# AOT700S

**Engineered for increasingly complex surgical scenes, AOT700S comes with intelligent automatic control system satisfying various demands of general surgeries.**

- *Longitudinal slide up to 350 mm for free access to C-arm*
- *Extreme weight load capacity of 300 kg with highest safety and stability*
- *Memory pad with antistatic, waterproof design*
- *Standard override panel control makes the control safer*
- *"Easy Click" leg plate controlled by electro-hydraulic and manual*
- *Battery power for 50-80 operations*



# AOT700S

## Double Control System

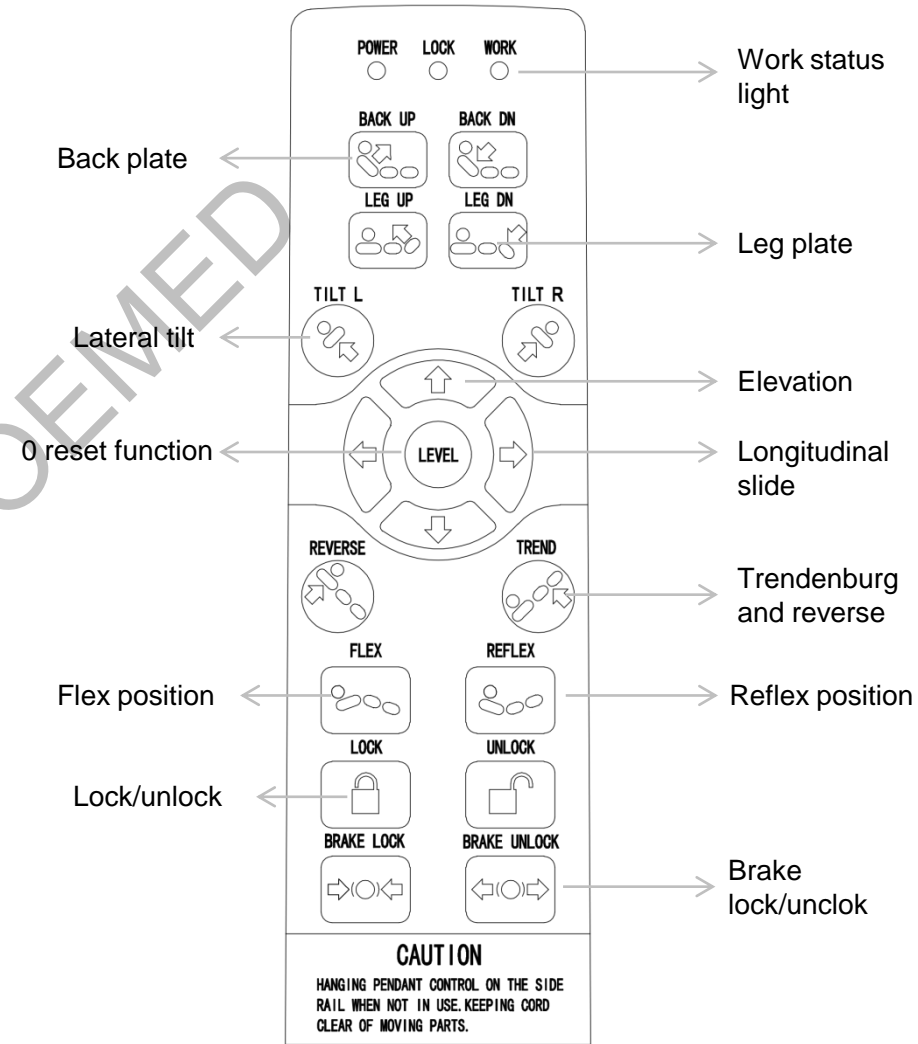

# A0T700S

## Details

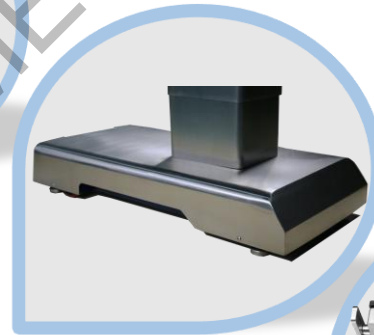

# AOT700S

## Details

*Maximum 350mm motorised longitudinal shift for flexible use of the C-arm*

*"Easy Click" for simple and quick module changes*

*Imported gas spring for easy controls*

*Maximum patient weight limit:  
300kg*



# AOT700S Technical Specification

## Dimensions

Full Length	2170mm
Width	550mm
Height (Lowest)	690mm
Height (Highest)	1100mm



## Kidney Bridge

Kidney Bridge elevation 110mm

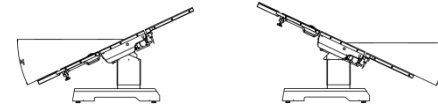

## Head Plate

Head Plate up	40°
Head Plate down	90°

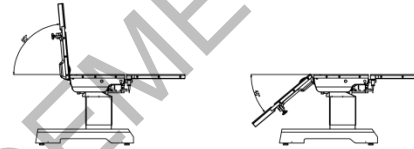

## Leg Plates

Leg Plates up	15°
Leg Plates down	90°

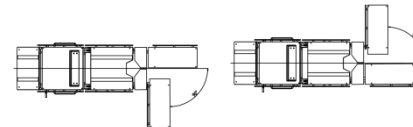

## Lateral Tilt

Lateral Tilt right	20°
Lateral Tilt left	20°



## Trendelenburg Position

Trendelenburg	30°
Reverse-Trendelenburg	30°



## Back Plate

Back Plate up	90°
Back Plate down	40°

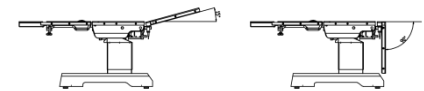

## Leg Plate Horizontal position

Leg Plate left	90°
Leg Plate right	90°



## Horizontal Sliding

Horizontal Sliding	350mm
--------------------	-------



### STANDARD ACCESSORIES

---

Anesthetic Screen	1 Piece
Kidney Bridge Handle	1 Piece
Shouder Support	1 Pair
Body Support	1 Pair
Arm Support	1 Pair
Long Fixing Clamp	1 Pair
Leg Support	1 Pair
Foot Support	1 Pair
Fixing Clamp	8 Pieces
Hand Remote	1 Piece
Mattress	1 Set
Power Line	1 Piece



# A0T700S

## Optional Accessories

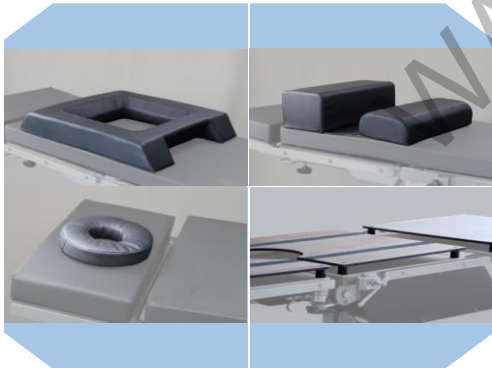
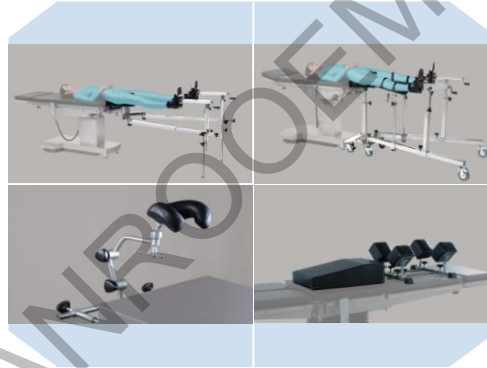
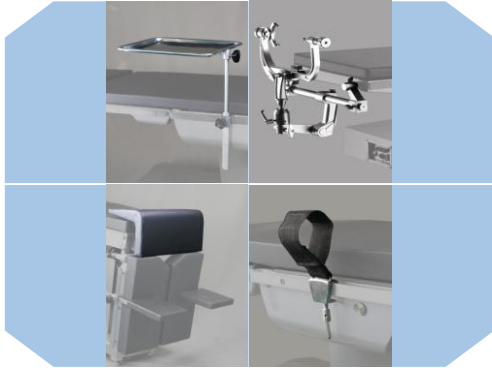



# Contact Us



**WANROOEMED**

**WANROOE MACHINERY CO., LTD.**

Tel:+86 512 58810860

Fax:+ 86 512 58810663

Email:info@wanrooemed.com

Http://wanrooemed.com

[Http://wanrooemed.com](http://wanrooemed.com)